

Multi-Pure®

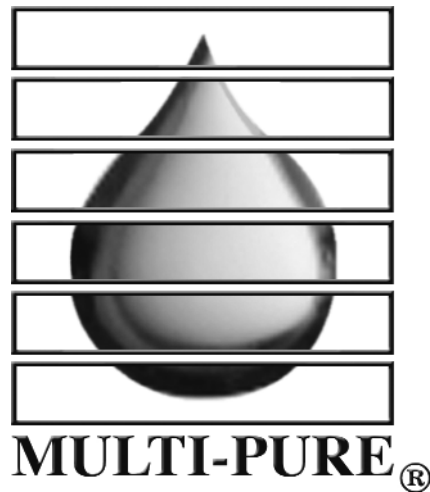

Aqua Dome Drinking Water Appliance
For Countertop Use

MODEL NOS. MPAD AND MPADC

Owner's Manual

Multi-Pure Drinking Water Systems

Thank you for selecting a Multi-Pure Drinking Water System to meet your need for quality drinking water. You have acquired one of the finest drinking water treatment devices available for the reduction of a wide array of contaminants. We are confident that your Multi-Pure System will make a difference in your life. Thank you for your business.

Table of Contents

I. Operation & Maintenance Specifications	2
II. Installation instructions - Inspect the housing	3
III. Installation instructions - Connect the hose to the housing	4
IV. Installation instructions - Connect the diverter valve to your faucet	4-5
V. Start-up and use of your Aqua Dome System	5
VI. Filter Life	6
VII. Product Registration ...	6
VIII. Instructions for Replacing Your Filter	7-8
IX. Product Warranty and Customer Satisfaction Guarantee	9
X. Product Certification	9
XI. Performance Data Sheet	10-12
XII. California Certification	13
XIII. Troubleshooting	14
XIV. Questions and Answers	15

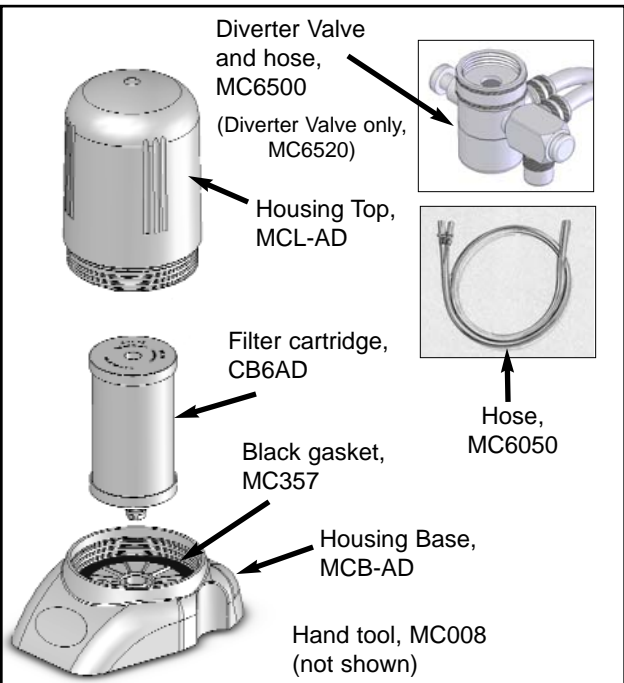
I. Operation and Maintenance Specifications	Aqua Dome Parts																																		
<table border="1" style="width: 100%; border-collapse: collapse;"> <thead> <tr> <th style="width: 30%;"></th> <th style="text-align: center;">Aqua Dome Models</th> </tr> </thead> <tbody> <tr> <td>Model Numbers</td> <td>MPAD and MPADC</td> </tr> <tr> <td>Housing Composition</td> <td>Polypropylene</td> </tr> <tr> <td>Rubber Items</td> <td>Nitrile</td> </tr> <tr> <td>Inlet</td> <td>3/8" stem</td> </tr> <tr> <td>Outlet</td> <td>1/4" stem</td> </tr> <tr> <td>Replacement Filter Type</td> <td>CB6AD</td> </tr> <tr> <td>Approximate Filter Cost</td> <td>\$60 +</td> </tr> <tr> <td>Approximate Filter Capacity</td> <td>750 gallons</td> </tr> <tr> <td>Approximate Flow Rate @ 60 psi</td> <td>0.75 gpm</td> </tr> <tr> <td>Maximum Working Pressure</td> <td>100 psi/7.0 kg/cm²</td> </tr> <tr> <td>Minimum Working Pressure</td> <td>30 psi/2.1 kg/cm²</td> </tr> <tr> <td>Maximum Operating Temperature</td> <td>100F / 38C - for cold water use</td> </tr> <tr> <td>Minimum Operating Temperature</td> <td>32F / 0C</td> </tr> <tr> <td>Particle Retention Size</td> <td>0.5 micron (sub micron)</td> </tr> <tr> <td>Certified by:</td> <td>NSF</td> </tr> <tr> <td colspan="2" style="padding-top: 5px;">+ plus tax and shipping and handling</td> </tr> </tbody> </table>		Aqua Dome Models	Model Numbers	MPAD and MPADC	Housing Composition	Polypropylene	Rubber Items	Nitrile	Inlet	3/8" stem	Outlet	1/4" stem	Replacement Filter Type	CB6AD	Approximate Filter Cost	\$60 +	Approximate Filter Capacity	750 gallons	Approximate Flow Rate @ 60 psi	0.75 gpm	Maximum Working Pressure	100 psi/7.0 kg/cm ²	Minimum Working Pressure	30 psi/2.1 kg/cm ²	Maximum Operating Temperature	100F / 38C - for cold water use	Minimum Operating Temperature	32F / 0C	Particle Retention Size	0.5 micron (sub micron)	Certified by:	NSF	+ plus tax and shipping and handling		 <p style="margin-left: 20px;"> Diverter Valve and hose, MC6500 (Diverter Valve only, MC6520) Housing Top, MCL-AD Filter cartridge, CB6AD Black gasket, MC357 Housing Base, MCB-AD Hand tool, MC008 (not shown) Hose, MC6050 </p>
	Aqua Dome Models																																		
Model Numbers	MPAD and MPADC																																		
Housing Composition	Polypropylene																																		
Rubber Items	Nitrile																																		
Inlet	3/8" stem																																		
Outlet	1/4" stem																																		
Replacement Filter Type	CB6AD																																		
Approximate Filter Cost	\$60 +																																		
Approximate Filter Capacity	750 gallons																																		
Approximate Flow Rate @ 60 psi	0.75 gpm																																		
Maximum Working Pressure	100 psi/7.0 kg/cm ²																																		
Minimum Working Pressure	30 psi/2.1 kg/cm ²																																		
Maximum Operating Temperature	100F / 38C - for cold water use																																		
Minimum Operating Temperature	32F / 0C																																		
Particle Retention Size	0.5 micron (sub micron)																																		
Certified by:	NSF																																		
+ plus tax and shipping and handling																																			

INSTALLATION, OPERATION & MAINTENANCE MANUAL

Multi-Pure Aqua Dome Drinking Water Appliance

The Multi-Pure Aqua Dome Drinking Water Appliance, Model MPAD is designed for use on the countertop next to your sink. You can connect it to your existing faucet using the high-tech chrome diverter valve that allows you to easily switch from filtered to unfiltered water.

Instructions for installing all Aqua Dome models (MPAD and MPADC) are as follows.

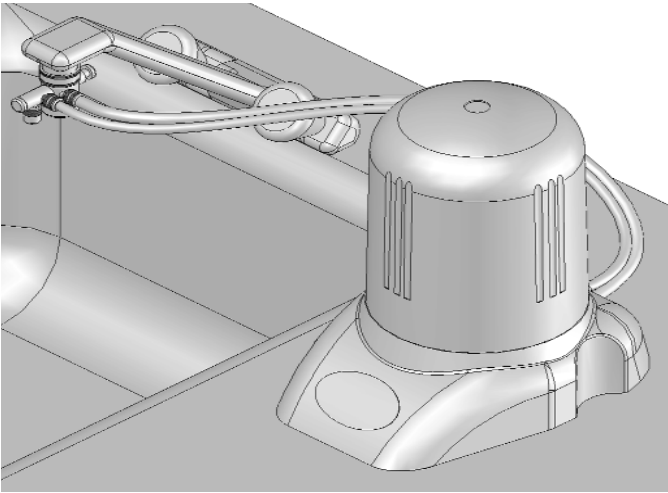

II. Inspect the Housing

NOTE: The filter cartridge is factory-installed inside the unit housing.

Step 1 Determine a desired location on your countertop for the unit so that the hose can easily be attached to your faucet.

Step 2 Inspect the unit housing to confirm that the housing top is securely connected to the bottom.

- a. With the housing in an upright position, slide the hand tool over the top so that the ridges on the tool fit into the grooves on the housing top.
- b. Applying steady pressure, turn clockwise to tighten. Hold the base in place on the countertop while turning the top.

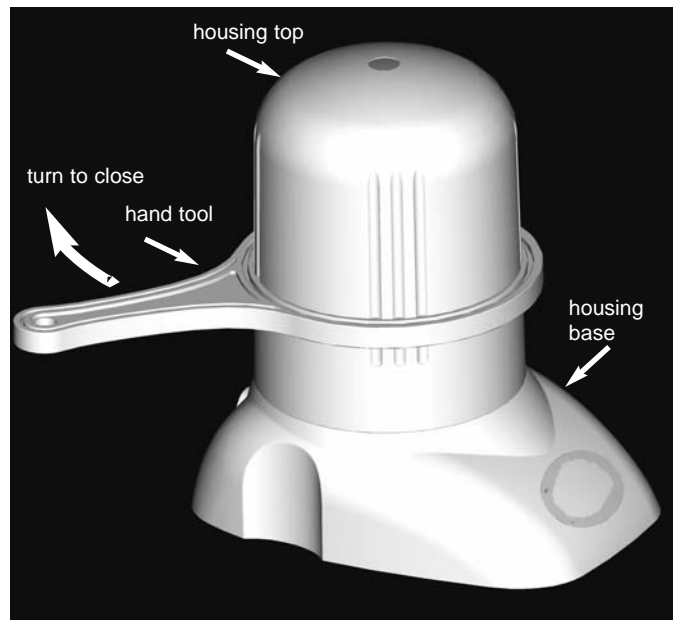

III. Connect the Hose to the Housing

NOTE: The Aqua Dome comes with a diverter valve and hose that connects the drinking water system to your faucet.

Step 3 To connect the hose to the housing base, insert the stems on the end of the hose into the inlet and outlet ports.

- Insert the larger stem into the bottom port (Inlet connector) by slowly pushing the stem straight into the connector as far as it will go. Give a second push to confirm that the stem is fully inserted.
- Insert the smaller stem into the top port (Outlet connector) by slowly pushing the stem straight into the connector as far as it will go. Give a second push to confirm that the stem is fully inserted.

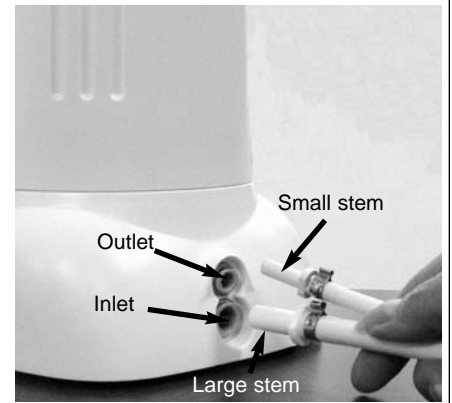

IV. Connect the Diverter Valve to Your Faucet

NOTE: The Aqua Dome Drinking Water Appliance is easy to install on most standard faucets. And, it includes a feature that makes it easy to switch from filtered to unfiltered water.

Step 4 Remove the aerator or screen from the end of your faucet. The water at your sink should be turned off.

Step 5 Attach the Diverter Valve directly to the faucet spout. If the threads of the Diverter Valve don't match the threads of your faucet, use one of the adapters provided with your unit.

- Faucets with Outside Threads:** For most faucets with outside threads, the diverter valve can be attached directly to the faucet. However, if the Diverter Valve is smaller than your faucet, attach the adapter with inside threads directly to your faucet and then attach the Diverter Valve to the adapter.
- Faucets with Inside Threads:** If your faucet has threads on the inside, attach one of the two adapters with outside threads (choose the appropriate size for your faucet) directly to your faucet and then attach the Diverter Valve to the adapter.
- Faucets with No Threads:** If your faucet has no threads, you will need to measure the inside neck diameter of the faucet and provide this information to your Multi-Pure Distributor. They will provide you with a special expandable adapter to fit your faucet in exchange for the adapters shipped with the unit.
- Faucets with Odd Sized Threads:** If your faucet does not fit any of the adapters provided with your unit, send your threaded aerator or screen to your Multi-Pure Distributor so that they can supply you with the correct adapter to meet your needs. We recommend that you first call the Multi-Pure Customer Relations Department at 800-622-9206.
- Faucets requiring more clearance for the connection, such as sprayer hose faucets, would use a long adapter (MC257).** See Step 5.e. on next page for installation instructions.

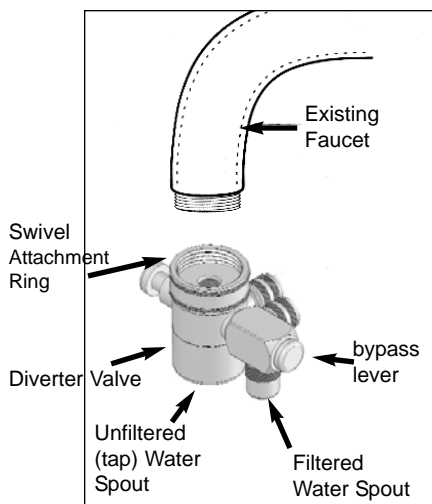

Diverter Valve Attachment

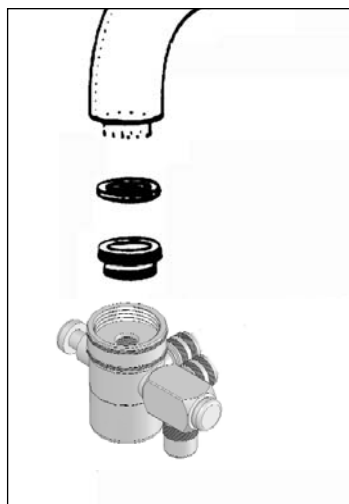

Diverter Valve Attachment with adapter

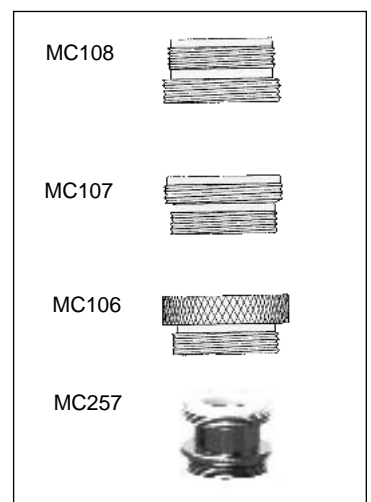

Adapters (choose one)
Many installations do not require an adapter

IV. Connect the Diverter Valve to Your Faucet (continued)

Step 5.e Instructions for Installing a Long Adapter

The long adapter (MC257) shown in Fig. 1 is used to connect the Hose & Diverter Valve assembly to your faucet or sprayer hose faucet, needing more clearance for the connection.

1. Remove the aerator or screen from your faucet.
2. Take the long adapter and attach it to the opening of the spout/sprayer then connect the Hose & Diverter Valve assembly to the adapter (Fig. 2).
3. Position the Drinking Water System on the sink to allow enough room to use the sprayer faucet.



Fig. 1



Fig. 2

V. Start-up and Use of Your Countertop Drinking Water System

Congratulations, your Multi-Pure Aqua Dome Drinking Water Appliance has been connected to your faucet and you are now ready to start-up the unit, as follows:

Step 6 Using a paper towel or cloth, dry off all connections. Also, dry off the drinking water unit.

Step 7 Ensure that all connections are tight (CAUTION: DO NOT OVER TIGHTEN).

Step 8 Before starting the flushing and start-up process, unscrew and remove the aerator (screen) from the filtered water spout. Rinse out the aerator to remove any debris that may have collected on the two screens inside it. You will reconnect the aerator upon completion of the filter flushing process.

Step 9 To purge all air from the unit, turn the housing **upside down** and then turn on the water. Push the bypass lever of the diverter to start the flow of water through the unit. Allow the water to run through the unit and filtered water spout for one minute. Then close the bypass lever and shut off the water at the faucet.

Step 10 Turn the unit right side up and place it on your counter and check all connections to confirm that there are no leaks.

Step 11 Turn on the water and push the bypass lever of the diverter valve to again start the flow of water through the unit.

Step 12 Allow water to run through the unit to waste for approximately 25 minutes to fully flush the filter and charge the carbon.

Step 13 Push the bypass lever inward to shutoff the flow of water through the Aqua Dome System. Then shut off the water at your faucet and check for leaks.

Step 14 Lastly, reconnect the aerator to the filtered water spout.

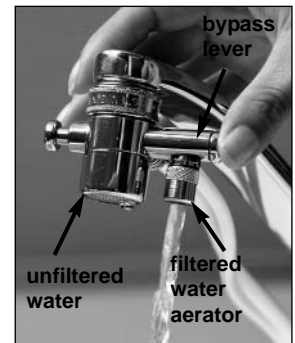

Turn Unit upside down to assure that all air escapes from the housing



Congratulations, you have completed the installation.

If you have any questions regarding the installation of your countertop unit, call:

**Multi-Pure Corporation
Customer Relations Department
7251 Cathedral Rock Drive
Las Vegas, NV 89128
(702) 360-8880 phone
(800) 622-9206 toll-free
(702) 360-3110 fax
email: custsvc@multipure.com
www.multipure.com**



VI. Filter Life

Filter life will vary in proportion to the amount of water used and the level of impurities in the water being processed. Claims of capacity are not applicable to contaminants reduced by mechanical filtration because of broad variations in the quality and quantity of physical matter in your drinking water. Your Multi-Pure filter will clog, protecting you from these contaminants, and your flow rate diminishes. For contaminants reduced by adsorption, filter life/capacity is 750 gallons.

It is recommended that filters be replaced annually or sooner if needed. For optimum performance and to maintain your warranty, it is essential that the filter be replaced on a regularly scheduled basis as follows: (a) annually; (b) when the unit's rated capacity (750 gallons) is reached; (c) the flow rate diminishes; (d) the filter becomes saturated with bad tastes and odors.

**For a Replacement Filter: Call (800) 622-9208
or go to
www.multipure.com/rf.htm**

VII. Product Registration

Thank you for choosing the Multi-Pure Aqua Dome Drinking Water Appliance. Multi-Pure is committed to providing the highest level of customer service. Please register your purchase with us so that we can better serve you should you need assistance. There are two ways to register your product purchase:

1. Register online at www.multipureco.com/productreg.htm

2. Register by mail. Please complete the below form and mail to:

Multi-Pure Corporation
Customer Service Department
7251 Cathedral Rock Drive
Las Vegas, NV 89128

or you may go online to fill out this form, www.multipureco.com/productreg.htm.

Name:		
Address (number and street):		
City:	State:	Zip:
Telephone Number:	Date of Purchase:	
E-mail address:	Model Series: Aqua Dome	
Distributor's Name (person from whom you purchased the Multi-Pure unit):		

Thank you. We appreciate your taking the time to register your purchase. The information you provide to us is used only by Multi-Pure to provide you with service. Your information is not shared with any other entity.

VIII. Instructions for Changing Your Filter

REMOVING THE OLD FILTER

1. Remove the shipping materials - plastic wrapper and instruction wrapper.
2. It may be advisable to place a folded towel beneath the housing before opening it. Or you may place it in your sink or in a pan to open.
3. Confirm that your tap water is off.
4. Open the diverter valve by pushing the bypass lever (Fig. A) so that the water flows through the unit and the filtered water spout until the flow stops.
5. When the flow of water stops, then close the diverter by pushing the bypass valve.
6. With the housing in an upright position, or on its side on a towel, use the Aqua Dome hand tool to open the unit (Fig. B).
 - a. Slide the hand tool over the housing top so that the ridges on the tool fit into the grooves on the housing top.
 - b. Hold the base in place on the countertop and apply steady pressure to the hand tool to turn the top.
 - c. Once the top is loose, you can complete the opening process by turning it with your hand.
7. Remove the housing top from the base, leaving the black gasket on the bottom of the base (Fig C).
8. Remove the old filter (cartridge) from the unit base by pulling out and slightly twisting the filter until it is released from the base as shown in Fig. D.
9. Wrap the used filter in paper and dispose of it in your normal refuse.
10. Clean and rinse out the inside of the housing.



Fig. A



Fig.B-1



Fig.B-2



Fig. C



Fig. D

INSTALLING THE NEW FILTER

11. Insert the new filter in the center port of the housing base, twisting slightly, as shown in Fig. D. Then push straight down on the filter to assure that it is firmly in place.
12. Reconnect the housing top with base (Fig. C).
13. Hand-tighten the housing top by turning it clockwise. The top should be securely connected to the base. If necessary, use the hand tool, shipped with your unit, to tighten the top (Fig. B-1).
 - a. With the housing in an upright position, slide the hand tool over the top so that the ridges on the tool fit into the grooves on the housing top.
 - b. Applying steady pressure, turn clockwise to tighten. Hold the base in place on the countertop while turning the top.

RE-STARTING YOUR AQUA DOME UNIT

14. Using a paper towel or cloth, dry off all connections and your drinking water unit.
15. Ensure that all connections are tight (CAUTION: DO NOT OVER TIGHTEN - see item #13c).
16. Before starting the flushing and start-up process, unscrew and remove the aerator (screen) from the filtered water spout (Fig. E). Rinse out the aerator to remove any debris that may have collected on the two screens inside it. You will reconnect the aerator upon completion of the filter flushing process (see step #24).
17. To purge all air from the unit, turn the housing **upside down** and then turn on the water at your tap faucet (Fig. F).
18. With the unit upside down, push the bypass lever of the diverter to start the flow of water through the unit (Fig. G). Allow the water to run through the unit and filtered water spout (without the aerator) for ONE minute. Then close the bypass lever and shut off the water at the faucet.
19. Turn the unit right side up, place it on your counter and check all connections to confirm that there are no leaks (Fig. H).
20. Turn on the water and push the bypass lever of the diverter valve to again start the flow of water through the unit (Fig. G).
21. Allow water to run through the unit to waste for approximately 25 minutes to fully flush the filter and charge the carbon (Fig G).
22. Push the bypass lever inward to shutoff the flow of water through the Aqua Dome unit.
23. Shut off the water at your faucet and check for leaks.
24. Then reconnect the aerator to the filtered water spout (Fig. E).

You now can resume using your Multi-Pure Drinking Water System for all your drinking water, cooking, and food preparation needs.

**For assistance, call
Multi-Pure's Customer Relations Department
800-622-9206**

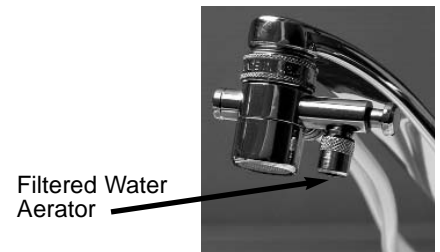

Fig. E



Fig. F

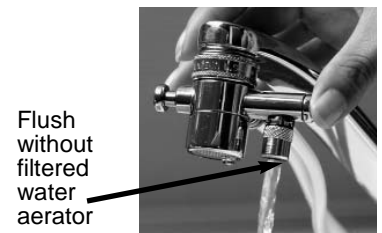

Fig. G



Fig. H



Fig. I

IX. Warranty

Multi-Pure 90-Day Guarantee: Multi-Pure demonstrates its confidence in the performance of its Drinking Water Systems by offering its 90 day money-back guarantee. If you should find the Drinking Water System unsatisfactory, let us know within thirty days of purchase, and we will promptly exchange it or refund your money.

Multi-Pure Warranty: Multi-Pure Corporation warrants to the original retail customer its Drinking Water Systems and components to be free of defects in material and workmanship for use under normal care, and will repair or replace any System at no charge (excluding transportation to Multi-Pure headquarters) to the customer during the warranty period. The Aqua Dome Housing is warranted for a lifetime (provided that filter has been changed at least once per year); all exterior hoses and attachments to the System are warranted for defects in material and workmanship for one year.

Multi-Pure Solid Carbon Block Filters are warranted for defects in material and workmanship for use under normal care. The capacity of the filter cartridge depends upon the amount of impurities in the water to be processed. For optimum performance, it is essential that the Solid Carbon Block Filter cartridge be replaced annually or when it has processed its listed capacity, whichever comes first.

Except as otherwise expressly provided above, Multi-Pure Corporation makes no warranties, express or implied, arising by law or otherwise, including without limitation the implied warranties of merchantability and fitness for a particular purpose, to any person. This limited warranty may not be altered, varied or extended except by a written instrument executed by Multi-Pure Corporation. The remedy of repair or replacement as provided under this limited warranty is exclusive. In no event shall Multi-Pure Corporation be liable for any consequential or incidental damages to any person whether occasioned by negligence of the manufacturer, including without limitation damages of loss of use, cost of substitution, property damage, or other monetary loss.

Warranty is valid only if Drinking Water System is operated within conditions listed herein.

X. Certification

Multi-Pure Drinking Water Systems Product Performance Tested and Certified



Multi-Pure Drinking Water Systems have been tested and certified by NSF International to comply with NSF/ANSI Standards 42 and 53 for the reduction of specific contaminants being considered as established or potential health hazards.

Standard 42, Aesthetic Effects

System tested and certified by NSF International against NSF/ANSI Standard 42 for the reduction of:

Chloramine
Chlorine taste and odor
Nominal Particulate reduction, class I

Standard 53, Health Effects

System tested and certified by NSF International against NSF/ANSI Standard 53 for the reduction of:

Asbestos	Chlordane
Cyst	Lead
Mercury	MTBE
PCB	Toxaphene
Turbidity	VOC (listed below)

Volatile Organic Chemicals (VOC) includes:

Disinfection By-Products

chloropicrin
haloacetonitriles (HAN):
bromochloroacetonitrile
dibromoacetonitrile
dichloroacetonitrile
trichloroacetonitrile
haloketones (HK):
1,1-dichloro-2-Propanone
1,1-trichloro-2-Propanone
trihalomethanes (THMs;
TTHMs):
bromodichloromethane
bromoform
chloroform
dibromochloromethane
tribromoacetic acid

Chemicals

benzene
carbon tetrachloride
chlorobenzene
1,2-dichloroethane
1,1-dichloroethylene
cis-1,2-dichloroethylene
1,2-dichloropropane
cis-1,3-dichloropropylene
ethylbenzene
hexachlorobutadiene
hexachlorocyclopentadiene
simazine
styrene
1,1,2,2-tetrachloroethane
tetrachloroethylene
toluene
trans-1,2-dichloroethylene
1,2,4-trichlorobenzene
1,1,1-trichloroethane
1,1,2-trichloroethane
trichloroethylene
xylenes (total)

Herbicides

alachlor
atrazine
2,4-D
dinoseb
pentachlorophenol
2,4,5-TP (silvex)

Pesticides

carbofuran
dibromochloropropane (DBCP)
o-dichlorobenzene
p-dichlorobenzene
endrin
ethylene dibromide (EDB)
heptachlor
heptachlor epoxide
lindane
methoxychlor

Filter capacity is
750 gallons, which is
approximately a 12 month supply
depending on local water conditions.

Claims of capacity are not applicable to contaminants reduced by mechanical filtration because of broad variations in the quality and quantity of physical matter in your drinking water.

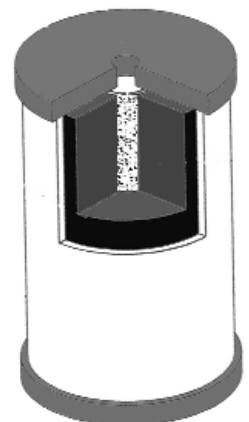

Performance Data Sheet

Multi-Pure Drinking Water Systems have been tested and certified under NSF/ANSI Standard Nos. 53 as shown below. The concentration of the indicated substances in water entering the system was reduced to a concentration less than or equal to the permissible limit for water leaving the system, as specified in NSF/ANSI 53, Health Effects.

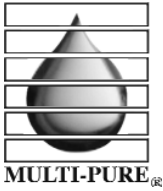

For Model Nos. MPAD and MPADC

Substance	Percent Reduction**	Influent challenge concentration (mg/L unless specified)	Maximum permissible product water concentration (mg/L unless specified)
ALACHLOR*	>98%	0.05	0.001
ASBESTOS	>99.9%	10 ⁷ to 10 ⁸ fibers/L; fibers greater than 10 micrometers in length	99% reduction requirement
ATRAZINE*	>97%	0.1	0.003
BENZENE*	>99%	0.081	0.001
BROMODICHLOROMETHANE (TTHM)*	>99.8%	0.300 +/- 0.30	0.015
BROMOFORM (TTHM)*	>99.8%	0.300 +/- 0.30	0.015
CARBOFURAN (Furadan)*	>99%	0.19	0.001
CARBON TETRACHLORIDE*	98%	0.078	0.0018
CHLORDANE	>99.5%	0.04 +/-10%	0.002
CHLOROBENZENE (Monochlorobenzene)*	>99%	0.077	0.001
CHLOROPICRIN*	99%	0.015	0.0002
CHLOROFORM (TTHM)* (surrogate chemical)	>99.8%	0.300 +/- 0.30	0.015
Cryptosporidium (CYST)	99.95%	minimum 50,000/mL	99.95%
CYST (Giardia; Cryptosporidium; Entamoeba; Toxoplasma)	99.95%	minimum 50,000/mL	99.95%
2, 4-D*	98%	0.110	0.0017
DBCP (see Dibromochloropropane)*	>99%	0.052	0.00002
1,2-DCA (see 1,2-DICHLOROETHANE)*	95%	0.088	0.0048
1,1-DCE (see 1,1-DICHLOROETHYLENE)*	>99%	0.083	0.001
DIBROMOCHLOROMETHANE (TTHM; Chlorodibromomethane)*	>99.8%	0.300 +/- 0.30	0.015
DIBROMOCHLOROPROPANE (DBCP)*	>99%	0.052	0.00002
o-DICHLOROBENZENE (1,2 Dichlorobenzene)*	>99%	0.08	0.001
p-DICHLOROBENZENE (para-Dichlorobenzene)*	>98%	0.04	0.001
1,2-DICHLOROETHANE (1,2-DCA)*	95%	0.088	0.0048
1,1-DICHLOROETHYLENE (1,1-DCE)*	>99%	0.083	0.001
CIS-1,2-DICHLOROETHYLENE*	>99%	0.17	0.0005
TRANS-1,2- DICHLOROETHYLENE*	>99%	0.086	0.001
1,2-DICHLOROPROPANE (Propylene Dichloride)*	>99%	0.08	0.001
CIS-1,3- DICHLOROPROPYLENE*	>99%	0.079	0.001
DINOSEB*	99%	0.17	0.0002
EDB (see ETHYLENE DIBROMIDE)*	>99%	0.044	0.00002
ENDRIN*	99%	0.053	0.00059
Entamoeba (see CYSTS)	99.95%	minimum 50,000/mL	99.95%
ETHYLBENZENE*	>99%	0.088	0.001
ETHYLENE DIBROMIDE (EDB)*	>99%	0.044	0.00002
Furadan (see CARBOFURAN)*	>99%	0.19	0.001

**Percent reduction reflects actual performance of Multi-Pure product as specifically tested (at 200% of capacity, i.e. 1500 gallons). Percent reduction shown for VOCs* reflects the allowable claims for Volatile Organic Chemicals/Compounds as per Tables. Chloroform was used as a surrogate for VOC reduction claims: the Multi-Pure Systems' actual reduction rate of Chloroform was >99.8% as tested (at 200% of capacity).

Substance	Percent Reduction**	Influent challenge concentration (mg/L unless specified)	Maximum permissible product water concentration (mg/L unless specified)
Giardia Lamblia (see CYST)	>99.95%	minimum 50,000/mL	99.95%
HALOACETONITRILES (HAN)*			
BROMOCHLOROACETONITRILE	98%	0.022	0.0005
DIBROMOACETONITRILE	98%	0.024	0.0006
DICHLOROACETONITRILE	98%	0.0096	0.0002
TRICHLOROACETONITRILE	98%	0.015	0.0003
HALOKETONES (HK):*			
1,1-DICHLORO-2-PROPANONE	99%	0.0072	0.0001
1,1,1-TRICHLORO-2-PROPANONE	96%	0.0082	0.0003
HEPTACHLOR*	>99%	0.25	0.00001
HEPTACHLOR EPOXIDE*	98%	0.0107	0.0002
HEXACHLOROBUTADIENE (Perchlorobutadiene)*	>98%	0.044	0.001
HEXACHLOROCYCLOPENTADIENE*	>99%	0.060	0.000002
LEAD (pH 6.5)	>99.3%	0.15 +/- 10%	0.010
LEAD (pH 8.5)	>99.3%	0.15 +/- 10%	0.010
LINDANE*	>99%	0.055	0.00001
MERCURY (pH 6.5)	>99%	0.006 +/- 10%	0.002
MERCURY (pH 8.5)	>99%	0.006 +/- 10%	0.002
METHOXYCHLOR*	>99%	0.050	0.0001
Methylbenzene (see TOLUENE)*	>99%	0.078	0.001
Monochlorobenzene (see CHLOROBENZENE)*	>99%	0.077	0.001
MTBE (methyl tert-butyl ether)	>96.6%	0.015 +/- 20%	0.005
POLYCHLORINATED BIPHENYLS (PCBs , Aroclor 1260)	>99.9%	0.01 +/- 10%	0.0005
PCE (see TETRACHLOROETHYLENE)*	>99%	0.081	0.001
PENTACHLOROPHENOL*	>99%	0.096	0.001
Perchlorobutadiene (see HEXACHLOROBUTADIENE)*	>98%	0.044	0.001
Propylene Dichloride (see 1,2 -DICHLOROPROPANE)*	>99%	0.080	0.001
SIMAZINE*	>97%	0.120	0.004
Silvex (see 2,4,5-TP)*	99%	0.270	0.0016
STYRENE (Vinylbenzene)*	>99%	0.15	0.0005
1,1,1-TCA (see 1,1,1 - TRICHLOROETHANE)*	95%	0.084	0.0046
TCE (see TRICHLOROETHYLENE)*	>99%	0.180	0.0010
1,1,2,2- TETRACHLOROETHANE*	>99%	0.081	0.001
TETRACHLOROETHYLENE*	>99%	0.081	0.001
TOLUENE (Methylbenzene)*	>99%	0.078	0.001
TOXAPHENE	>92.9%	0.015 +/- 10%	0.003
Toxoplasma (see CYSTS)	99.95%	minimum 50,000/mL	99.95%
2,4,5-TP (Silvex)*	99%	0.270	0.0016
TRIBROMOACETIC ACID*		0.042	0.001
1,2,4 TRICHLOROBENZENE (Unsymtrichlorobenzene)*	>99%	0.160	0.0005
1,1,1-TRICHLOROETHANE (1,1,1-TCA)*	95%	0.084	0.0046
1,1,2-TRICHLOROETHANE*	>99%	0.150	0.0005
TRICHLOROETHYLENE (TCE)*	>99%	0.180	0.0010
TRIALOMETHANES (TTHM) (Chloroform; Bromoform; Bromodichloromethane; Dibromochloromethane)	>99.8%	0.300 +/- 0.30	0.015
TURBIDITY	>99%	11 +/- 1 NTU	0.5 NTU
TRICHLOROBENZENE)*	>99%	0.160	0.0005
Vinylbenzene (see STYRENE)*	>99%	0.150	0.0005
XYLENES (TOTAL)*	>99%	0.070	0.001

NSF/ANSI 42 - Aesthetic Effects

The System has been tested according to NSF/ANSI Standard 42 for the reduction of the following substances. The concentration of the indicated substances in water entering the system was reduced to a concentration less than or equal to the permissible limit for water leaving the system.

Substance	Percent Reduction**	Influent challenge concentration (mg/L unless specified)	Maximum permissible product water concentration (mg/L unless specified)
CHLORAMINE as Aesthetic Effect (As Monochloramine)	>97%	3.0 mg/L +/- 10%	0.5 mg/L
CHLORINE as Aesthetic Effect	99%	2.0 Mg/L +/- 10%	> or = 50%
PARTICULATE, (Nominal Particulate Reduction, Class I, Particles 0.5 TO <1 UM	Class I > 99%	At Least 10,000 particles/mL	> or = 85%

Note: This addresses the U.S. Environmental Protection Agency (EPA) Primary and Secondary Drinking Water Regulations in effect at its time of publication, they relate to Multi-Pure's performance in conformance to the industry performance criteria. These regulations are continually being updated at the Federal level. Accordingly, this list of MCLs will be reviewed and amended when appropriate. Please see sales brochure for list of product certifications.

NOTES:

1. Multi-Pure Drinking Water Systems have been certified, as indicated, by NSF International for compliance to NSF/ANSI Standard Nos. 42 & 53.
2. The Multi-Pure Drinking Water Systems have been certified by the State of California Department of Health Services for the reduction of specific contaminants listed herein.
3. Chloroform was used as a surrogate for claims of reduction of VOCs. Multi-Pure Systems tested at >99.8% actual reduction of Chloroform. Percent reduction shown herein reflects the allowable claims for VOCs as per tables in the Standard.
4. **Do not use with water that is microbiologically unsafe or of unknown quality without adequate disinfection before or after the system. Systems certified for cyst reduction may be used on disinfected water that may contain filterable cysts.**
5. Filter life will vary in proportion to the amount of water used and the level of impurities in the water being processed. For optimum performance, it is essential that the filter be replaced on a regularly scheduled basis as follows: (a) annually; (b) when the unit's rated capacity has been reached; (c) the flow rate diminishes; (d) the filter becomes saturated with bad tastes and odors.
6. Multi-Pure's Aqua Dome Housing is warranted for a lifetime (provided that filter has been changed at least once per year). All exterior hoses and attachments to the System are warranted for one year. Please see the Owner's Manual for complete product guarantee and warranty information.
7. Please see the Owner's Manual for installation instructions and operating procedures.
8. In compliance with New York law, it is recommended that before purchasing a water treatment system, NY residents have their water supply tested to determine their actual water treatment needs. Please compare the capabilities of the Multi-Pure unit with your actual water treatment needs.
9. Check for compliance with state and local laws and regulations.
10. While testing was performed under standard laboratory conditions, actual performance may vary.
11. The list of substances which the treatment device reduces does not necessarily mean that these substances are present in your tap water.



**Model Nos: MPAD
MPADC**

Operational Specifications	MPAD/ MPADC
Approximate Service Capacity (5)	750 gallons
Replacement Filter Type Model No./ Approx. Cost	CB6AD/\$60
Approximate Flow Rate @ 60 psi	0.75 gpm
Maximum Water Pressure	100 psi/7.0 kg/cm ²
Minimum Water Pressure	30 psi/2.1 kg/cm ²
Maximum Operating Temperature	100°F/38°C for cold water use only
Minimum Operating Temperature	32°F/0°C

XII. California Certification

State of California
Department of Health Services
Water Treatment Device
Certificate Number
05 - 1736

Date Issued: October 20, 2005

Trademark/Model Designation

Multi-Pure MPAD
Multi-Pure MPADC

Replacement Element(s)

CB6AD
CB6AD

Manufacturer: Multi-Pure Drinking Water Systems

The water treatment device(s) listed on this certificate have met the testing requirements pursuant to Section 116830 of the Health and Safety Code for the following health related contaminants:

Microbiological Contaminants and Turbidity

Cysts
Turbidity

Inorganic/Radiological Contaminants

Asbestos
Lead
Mercury

Organic Contaminants

Chlordane
MTBE
PCB
Toxaphene
VOCs

Alachlor
Atrazine
Benzene
Carbofuran
Carbon Tetrachloride
Chlorobenzene
Chloropicrin
2,4-D
DBCP
o-Dichlorobenzene
p-Dichlorobenzene
1,2-Dichloroethane
1,1-Dichloroethylene
cis-1,2-Dichloroethylene
trans-1,2-Dichloroethylene
1,2-Dichloropropane
cis-1,3-Dichloropropylene
Dinoseb

Endrin
Ethylbenzene
EDB
Haloacetonitriles (HAN)
Bromochloroacetonitrile
Dibromoacetonitrile
Dichloroacetonitrile
Trichloroacetonitrile
Haloketones (HK)
1,1-Dichloro-2-Propanone
1,1,1-Trichloro-2-Propanone
Heptachlor
Heptachlor Epoxide
Hexachlorobutadiene
Hexachlorocyclopentadiene
Lindane
Methoxychlor
Pentachlorophenol

Simazine
Styrene
1,1,2,2-Tetrachloroethane
Tetrachloroethylene
Toluene
2,4,5-TP (Silvex)
Tribromoacetic Acid
1,2,4-Trichlorobenzene
1,1,1-Trichloroethane
1,1,2-Trichloroethane
Trichloroethylene
Trihalomethanes (THMs)
Bromodichloromethane
Bromoform
Chloroform
Chlorodibromomethane
Xylenes

Rated Service Capacity: 750 gals

Rated Service Flow: 0.75 gpm

Do not use where water is microbiologically unsafe or with water of unknown quality, except that systems certified for cyst reduction may be used on disinfected waters that may contain filterable cysts.

XIII. Troubleshooting

Problem	Cause	Remedy
Taste/Odor (general)	The carbon block filter may become saturated with the taste and odors it adsorbs.	Change the filter
Rotten egg odor	Typically a sign of H ₂ S (hydrogen sulfide) gas which can occur at any time.	It is recommended that you keep two filter cartridges on hand. When one becomes saturated with odor, remove it and allow it to dry upside (threaded-hole) down on a paper towel. The sulfur gas will dissipate, allowing the cartridge to be reused. Rotating cartridges in this manner will, in some cases, help extend the life of the filter.
Odor & odd color on cartridge	H ₂ S (hydrogen sulfide) caused by iron (orange/brownish), manganese (blackish), and/or decaying organisms (slimy/blotchy colors) can cause rotten egg-type odor.	Change of filter cartridge is the only recommended course of action.
"Milky" color in water	Higher than normal water pressure through the System will create small bubbles. Air bubbles do not effect the performance of the system. Air can be trapped inside the lid of the housing.	For a countertop installation, turn on the water and engage the diverter valve while reducing the water flow slightly. For a below the sink installation, adjust the water pressure at the feedwater adapter below the sink. Turn on the ledge faucet or diverter valve and let water run for 3 to 5 minutes after installation or filter change.
Flow rate is slow	Solids: The filter is designed to become restricted in its flow rate when the filter becomes clogged with particulate and other contaminants. When your water flow rate slows to the point that it is inconvenient to use, it is time to change your filter.	It is recommended that filters be replaced at least every twelve months or when its capacity is reached, whichever comes first. If water pressure is too low, adjust water pressure to 60 psi. If other faucets or sprinklers are on turn off other running water.
Water dripping from faucet assembly	Adjustment of water flow is needed.	Below sink units - remove the faucet handle by first removing the spout (pull straight up) and then slide the handle off the faucet base. Then turn the small t-bar about one half turn to tighten the faucet assembly.
Water is black	Carbon dust	Allow water to run through the unit to waste for approximately 20 minutes to flush the filter and charge the carbon.

Maintenance Problems

Flushing / disinfecting the unit housing: Multi-Pure recommends that you not allow water to sit in a unit for extended periods of time without it being used. If a unit is left unused for more than 10 days, it may need to be flushed/disinfected before you resume use.

To flush a unit that may be contaminated:

1. Confirm that water is turned off to the unit.
2. Relieve the water pressure (if below sink unit) by opening the unit faucet.
3. Remove and discard the used filter.
4. Clean & rinse out the inside of the housing.
5. Add 5 to 7 drops of bleach, such as Clorox™ or Purex™ (5 ¼% sodium hypochlorite) to the bottom canister.
6. Reconnect the housing top and bottom without the replacement filter.
7. Turn on water and let unit housing fill up with the water/bleach solution.
8. Allow unit to soak for at least 30 minutes.
 - a. Countertop Units: To disinfect the spout, place your finger over the tip of the spout and turn the unit upside down. Repeat this procedure 2 or 3 times during the 30-minute soak period.
 - b. Below Sink Units: To disinfect the faucet spout, remove the spout and place it in a container with one-quart of water and bleach (use 5 drops of bleach) and allow to soak for 30 minutes.
9. After the housing has soaked for 30 minutes, disassemble the top and bottom and pour out the water/bleach solution. Rinse out the inside of the housing.
10. Replace the filter (cartridge) following the instructions with the new filter.
11. Follow the instructions with the replacement filter for reconnecting and flushing your unit.

Stuck / Sticking Diverter Valve: Normally caused by a mineral (calcium) buildup around the diverter stem. There are two methods for solving this problem (Vegetable Oil or Vinegar).

Vegetable Oil (Using vegetable oil to lubricate the diverter valve does not dissolve the mineral deposits which build up and cause the sticking; thus it will be necessary to repeat this procedure from time to time)

1. Unscrew diverter valve from faucet.
2. Pour a little vegetable oil in the inlet hole.
3. Pull the diverter valve stem in/out several times to lubricate it thoroughly.
4. Replace diverter valve on faucet.

Vinegar (Using vinegar to dissolve the mineral deposits may cause discoloration)

1. Unscrew diverter valve from faucet.
2. Soak diverter valve in vinegar for 10 minutes.
3. Rinse and replace diverter valve on faucet.

If these methods don't work, it may be necessary to replace the diverter valve. Please contact Multi-Pure Customer Service at 800-622-9206 for assistance.

Diverter Stem Stuck (If diverter stem is not operating properly - sticking)

1. Disconnect diverter valve from faucet.
2. Push pin in -- if you can push the pin easily, there was air in the tubing.
3. Reconnect diverter valve.

XIV. Questions and Answers

Question	Answer	Comments
Will low pH or acid water affect the Multi-Pure filter?	No.	Mineral components expressed as acidity and alkalinity determine pH. Neutrality is 7; below 7 is acidity; above 7 is alkalinity.
Does deionized water or soft water have any affect on Multi-Pure water?	No.	N/A
Can the Multi-Pure System be connected to an automatic ice-maker?	The below sink models can be connected to both your sink and refrigerator, to any type of water dispenser or ice-maker. You can use the same unit installed under your sink to also filter the water at your refrigerator.	To connect a single Drinking Water System to both your sink and refrigerator, request an "ice-maker tee" on the order form.
Can the Multi-Pure System be used during an emergency or when the water is turned off?	Yes, you can hand pump or siphon water through the Multi-Pure System during an emergency. CAUTION -- the Multi-Pure System is not intended to be used where the water is microbiologically unsafe or with water of unknown quality without adequate disinfection before or after the unit.	If water source is questionably contaminated, it should be disinfected prior to use. Add ¼ tsp of household bleach per gallon of water; the Multi-Pure System will remove this solution from the water. Hand pump kits are available from Multi-Pure.
What causes "white" particles to appear in Multi-Pure water when it is frozen or boiled?	The natural minerals in the Multi-Pure water solidify when the water is frozen, and those minerals appear as white flakes or specks when the ice melts.	Natural minerals are beneficial to good health and their existence in drinking water (in normal quantities) should not cause any alarm. Minerals can be removed by Reverse Osmosis technology, which is also available from Multi-Pure on request.
Why does the Multi-Pure System reduce Volatile Organic Chemicals, but not natural minerals?	Minerals are totally dissolved in solution and do not have an actual physical size; thus, the minerals pass through the filter unchanged.	The materials used in Multi-Pure Drinking Water Systems are specially selected for their ability to react with the chemicals in the water, but not with natural minerals that are beneficial to good health.
Should sediment be removed with a standard filter first?	In areas with excessive sedimentation, prefiltration will help extend the operational efficiency of the Multi-Pure cartridge; however, in most areas this is not necessary.	The Multi-Pure System contains a triple filter. The outside material is a prefilter that helps protect the solid carbon block surface from prematurely clogging with large sediment.
Why is the compressed activated carbon block filtration system more efficient than activated carbon (loose granular) systems?	Multi-Pure's solid carbon block filters are compacted into a dense structure causing every molecule of water to be forced through microscopic pores of carbon, effectively reducing a wide range of contaminants of health concern (see Section 3), as well as adsorbing tastes and odors and removing particulate matter removed by typical activated carbon filters.	The Water Quality Association reports that "an activated carbon filter can reduce organics and solid particles, as well as offensive tastes and odors." Only precoat and solid carbon block filters are engineered to provide 0.5 micron mechanical filtration.
What is the difference between a "water softener" and the Multi-Pure Drinking Water System?	Softeners are not used to treat drinking water; they are used only to change the water hardness. Softeners put sodium into the water in exchange for magnesium or calcium ions. Multi-Pure Drinking Water Systems do not remove dissolved minerals, so, the pH is not changed. Natural minerals most often found in water are considered to be essential to good health.	Soft water is good for bathing and laundering and may extend the life of hot water heaters and boilers. However, soft water should not be used for watering plants or lawns. It is recommended that you bypass a water softener when installing your Multi-Pure Drinking Water System.
Can the Multi-Pure System be used on untreated water?	If water source is questionable, it should be disinfected prior to use. Add ¼ tsp of household bleach per gallon of water; the Multi-Pure System will remove this solution from the water. Consult your nearest public water utility for assistance or guidelines on proper treatment of untreated water.	Multi-Pure Systems are designed to be used on treated water systems; they are not intended to be used where the water is microbiologically unsafe or with water of unknown quality without adequate disinfection before or after the unit. Systems certified for cyst reduction may be used on disinfected waters that may contain filterable cysts.

For instructions in Spanish, please turn the manual over.

Be sure to replace your filter at least once a year, or sooner if needed.

Date of Installation: _____ <i>Fecha de Instalación</i>
Unit Model Number: _____ <i>Tipo de Unidad</i>
Filter Type: _____ <i>Tipo de Filtro</i>
Dates of Filter Change / <i>Fechas de Cambio del Filtro</i>

To order a Replacement Filter

Call 1-800-622-9208

or

www.multipure.com/rf.htm



Multi-Pure Corporation

Las Vegas Technology Center
7251 Cathedral Rock Drive
Las Vegas, NV 89128
800-622-9206
email: headquarters@multipure.com
www.multipure.com